



MM5000 (Tornado) series

Video Wall Processor

User Manual



Multiple views, multiple lives
Shanghai Mviewtech Co., Ltd
www.mviewtech.com

Content

Product Overview.....	1
Product Features	2
Specification Sheet	5
Input / Output Card	6
Contact Us	16

Product Overview

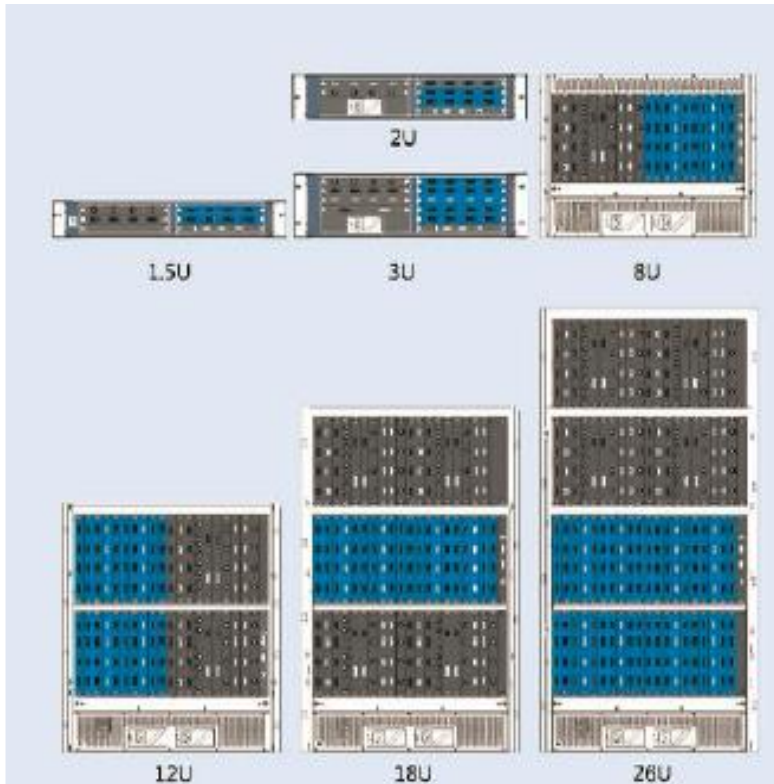

MM5000 (Tornado) series Video Wall Processor
(1.5U, 2U, 3U, 8U, 12U, 18U, 26U)

MM5000 (Tornado) series Video Wall Processor is one high performance video/image processing system adopted pure hardware wire speed architecture. MM5000 is applied widely in education research, government notice, information publication, administrative management, military command, exhibition display, security monitoring, sales activities etc. With powerful signal processing ability, it is capable of multiple HD/UHD image/video signal sources capturing, Real-time processing of high-resolution digital image, and complex image conversion functions.

No Pixel Loss

Adopted patent lossless algorithm, MM5000 solves the frame loss problems of the common processor.

Run Smoothly

The ultra-parallel processing mechanism and full-synchronous processing architecture ensure all input signals to each output screen in synchronization, and the images have no dropped frames and no tearing.

Compatible & Flexible

The design of expandable input slot supports for arbitrary mixing of input cards. MM5000L, which supports for 4K, is able to customize the irregular resolutions and flexible window roaming, screen scaling.

Product Features

I Architecture I

- **FPGA architecture**
MM5000 without embedded operation system has excellent image processing performance based on Flexview M8 processing algorithm.

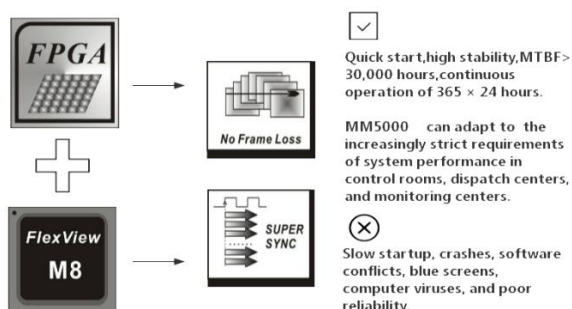

MM5000 adopted the 4th generation hardware processing architecture and Flexview M8 algorithm supports pixel by pixel output, receiving multiple 4K/8K signals sources, and real-time processing without frame loss. With the help of high speed paralleled processing, super sync and full frame technologies, the processor guarantees all outputs in super sync and no image tearing.

I Input cards I

- **Different combinations of multiple input cards** support DVI-M, HDMI, Displayport, VGA, DVI, DualLink DVI, SDI, CVBS, HDBaseT, YPbPr/YCbCr, IP.

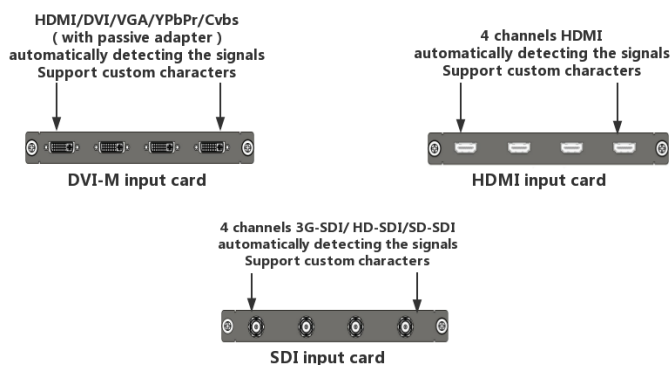

Displayport 1.2/HDMI 2.0 input card supports 4K@60Hz, 8K@30Hz and other self-defined resolutions.

Displayport 1.1/HDMI 1.4b/Duallink DVI input card supports 4K@30Hz and other self-defined resolutions.

Product Features

- **UHD input card** supports up to 8Kx4K with multiple inputs in synchronization.

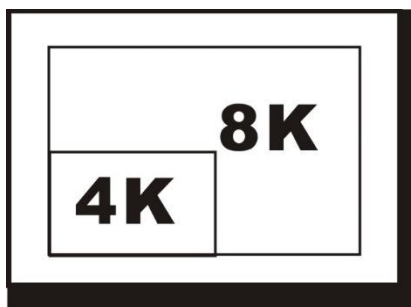

- **Expandable input slot** offers more possibilities.

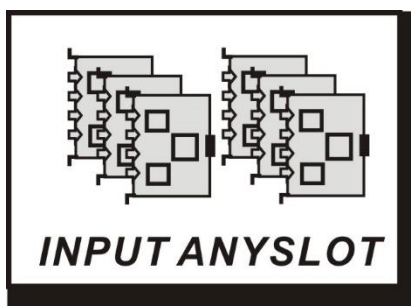

I Output Cards I

- HD and SD output cards support 800x600-2048x1200 @60Hz resolution, and simultaneously support active stereo output 1024x768-1280x800 @120Hz.
- UHD output card supports 1920x1080@120Hz ,4K@60Hz, 4K@30Hz.
- Support arbitrary angle rotation and pitch creative splicing . (optional)
- The output supports redundant backup to prevent accidental electrostatic damage.

I System Control I

- Support LAN or RS232 remote control.
- Support external RS232 to control matrix and projector.
- Support redundant power and visual operation on all universal platform.

Product Features

I Multi-window Capability I

- Flexible multi-window capability supports to display multiple signals in strict synchronization.
- Support up to 7 HD layers in single output.

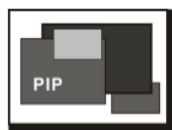

PIP

The window layers can overlap, so-called "picture in picture" function, which makes the way to layout more flexible and freer. The smaller picture is not controlled by the area of the lower picture, and can be displayed across the boundary of the larger one.



EDID

Support EDID (Extended Display Identification Data) reading, modification, resolution supported by custom Displayport input (up to 8Kx4K), which greatly improves the compatibility with large screen display devices, making the output adapt to various conventional and non-conventional applications.

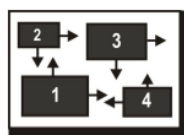

Window roaming

The signal window can be roamed freely in the background picture of all outputs to display at any position on the big screen.

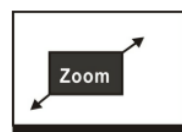

Zooming function

Each layer can be scaled arbitrarily, meanwhile, the height and width can be enlarged or reduced individually or in combination. Compensated by unique video processing algorithms, the image quality is not lost.

- In addition, MM5000 supports "**Scan line and refresh rate doubling**", "**Seamlessly real-time switching**", and "**Black border erasing / cropping**" to improve the overall image quality.

Scan line and refresh rate doubling	The scan line or refresh rate of image signals can be doubled to improve the quality of the low frame rate signal, which enhances screen overall quality greatly.
Seamlessly real-time switching	HD signal processing mechanism based on internal hardware ensures that single or multiple signals can be seamlessly switched in real time.
Black border erasing / cropping	MM5000-B can perfectly solve the problem of black border caused by front-end signals (especially non-standard camera output signals).

Specification Sheet

Product	MM5000 (Tornado) series Video Wall Processor
Input	
Input Card and Signal Format Supported	<ol style="list-style-type: none"> 1. Different combinations of multiple input formats, including DVI-M, HDMI,,Displayport, VGA, DVI, DualLink DVI, SDI, CVBS, HDBaseT, YPbPr/YCbCr, IP. 2. DVI-M input card is compatible with HDMI, DVI, VGA, YPbPr and Cvbs via passive adapter; 3. Displayport 1.2/HDMI 2.0 input card support 4K@60Hz, 8K@30Hz and other self-defined resolutions; 4. Displayport 1.1/HDMI 1.4b/Duallink DVI card support 4K@30Hz and other self-defined resolutions.
Max Num. of Input Cards	3 cards/1.5U; 3 cards /2U; 9 cards /3U; 18 cards /8U; 36 cards /12U, 40 cards /18U, 40 cards /26U
Output	
Output Card and Signal Format Supported	<ol style="list-style-type: none"> 1. Multiple output options : DVI-I, HDMI 4K, Duallink DVI, HDBaseT etc. 2. Support creative splicing output card to achieve pixel-by-pixel display.
Max Num. of in&out channel	160 channels
Other Image/Video Processing Function	
Image/Video Processing Capability	<ol style="list-style-type: none"> 1. Support single screen split / screen overlay / multi-screen display 2. Support all signal output in sync, and real-time echo 3. Support window overlap, roaming, moving, zooming and cropping etc. 4. Support character overlay and customizing characters 5. Support any rectangle LED splicing and output remapping 6. Support LED installed in any angle(optional)
Control Spec	
Network Control	RJ - 45 X1,adaptive for cable up10M/100M, open API
Serial Port Control	RS - 232X 2, can be controlled by the 3rd part device as switcher or screen
Panel Control	Support visual touch Pad and real-time display (optional)
Electrical Specifications and Reliability	
Power Supply	AC 100~240V / 50Hz ~ 60Hz
Power Consumption	Based on the num. of input and output cards
Operating Temperature	0—50°C
Operating Humidity	15-85%
Operating System	Pure hardware architecture without embedded operation system
Startup Time	Less than 3 seconds
Weight	Based on the real configuration
Accessories	AC Power cable 1.5m RS232 serial port cable, 2m network cable with RJ45 plug Software CD

Input / Output Cards

I Input cards I



4 Channels DVI-M Input Card

- Support HDMI/DVI/VGA/YPbPr/Cvbs
- Support up to 1920x1200@60Hz
- Support EDID、 OSD
- Support auto adjust for analog signal

Spec sheet		
Port	DVI-M (support HDMI/DVI/VGA/YPbPr/Cvbs with passive adapter)	
Spec	Input Signal	HDMI/DVI/VGA/YPbPr/Cvbs
	Input Signal Level	Refer to relevant
	Impedance	50ohm
	Input Bandwidth	165Mhz
	Input Channels	4
	Power Consumption	18w



4 Channels DVI Input Card

- Support HDMI/DVI
- Support up to 1920x1200@60Hz
- Support EDID、 OSD
- Support HDCP

Spec sheet		
Port	DVI-D	
Spec	Input Signal	HDMI/DVI
	Input Signal Level	TMDS
	Impedance	Differential 100ohm
	Input Bandwidth	165Mhz
	Input Channels	4
	Power Consumption	12W

Input / Output Cards



4 Channels HDMI Input Card

- Support HDMI/DVI
- Support up to 1920x1200@60Hz
- Support EDID、 OSD
- Support HDCP
- Support enhancing input function

Spec sheet		
Port	HDMI (Type A)	
Spec	Input Signal	HDMI/DVI
	Input Signal Level	TMDS
	Impedance	Differential 100ohm
	Input Bandwidth	165Mhz
	Input Channels	4
	Power Consumption	12W

- Support 4K HDMI
- Support up to 3840x2160@30Hz, 3840x1200@60Hz etc.
- Support EDID、 OSD
- Support HDCP



2 Channels HDMI 4K Input Card

Spec sheet		
Port	HDMI1.4b	
Spec	Input Signal	HDMI
	Input Signal Level	TMDS
	Impedance	Differential 100ohm
	Input Bandwidth	300Mhz
	Input Channels	2
	Power Consumption	12W

Input / Output Cards



Duallink DVI/Displayport Input Card

- Support Duallink DVI/Displayport/ DVI
- Support up to 3840x2160@30Hz, 3840x1200@60Hz etc.
- Support EDID、 OSD
- Support DP/HDCP

Spec sheet		
Port	Duallink DVI/ Displayport 1.1A	
Spec	Input Signal	DP/DVI-DL
	Input Signal Level	TMDS /CML
	Impedance	Differential 100ohm
	Input Bandwidth	330/360Mhz
	Input Channels	2
	Power Consumption	12W

- Support DP
- Support up to 3840x2160@30Hz, 3840x1200@60Hz etc.
- Support EDID、 OSD
- Support DP、 HDCP



2 Channels DP 4K Input Card

Spec sheet		
Port	Displayport 1.1A	
Spec	Input Signal	DP
	Input Signal Level	CML
	Impedance	Differential 100ohm
	Input Bandwidth	360Mhz
	Input Channels	2
	Power Consumption	12W

Input / Output Cards



DP1.2/HDMI 2.0 4K60/8K Input Card

- Support DP/HDMI
- Single port supports 7680x2160@30Hz, 3840x2400@60Hz etc.
- Support EDID、 OSD
- Support HDCP

Spec sheet		
Port	Displayport 1.2、 HDMI 2.0	
Spec	Input Signal	DP/HDMI
	Input Signal Level	CML/TMDS
	Impedance	Differential 100ohm
	Input Bandwidth	600Mhz
	Input Channels	2
	Power Consumption	18W

- Support 3G/HD/SD SDI
- Support up to 1920x1080@60Hz
- Support OSD
- supports long-line automatic equalization (100m)



4 Channels 3G/HD/SD SDI Input Card

Spec sheet		
Port	SDI BNCX4	
Spec	Input Signal	3G/HD/SD SDI
	Input Signal Level	2.0V VPP
	Impedance	75ohm
	Input Bandwidth	2.97gbps
	Input Channels	4
	Power Consumption	12W

Input / Output Cards



8 Channels Cvbs input card

- Support PAL, NTSC and SECAM video
- Support adjustment of video signal brightness, contrast and other parameters
- Support high-quality motion compensation
- Support OSD

Spec sheet		
Port	Analog BNC X8	
Spec	Input Signal	PAL、 NTSC、 SECAM
	Input Signal Level	1.0V VPP
	Impedance	75ohm
	Input Bandwidth	27Mhz/36 Mhz
	Input Channels	8
	Power Consumption	12W

- Support HDbaseT
- Support up to 1920x1200@60Hz
- Support EDID、 OSD
- Support input cropping
- Support HDCP



4 Channels HDbaseT Input Cards

Spec sheet		
Port	HDbaseT	
Spec	Input Signal	HDbaseT
	Input Signal Level	Refer to HDbaseT standards
	Input Bandwidth	165Mhz
	Input Channels	4
	Power Consumption	30W

Input / Output Cards



HDbaseT/HDMI 4K Input Card

- Support HdbaseT/HDMI
- Support up to 3840x2160@30Hz, 3840x1200@60Hz etc.
- Support EDID、OSD
- Support HDCP and input cropping

Spec sheet		
Port	HDbaseT 、 HDMI1.6b	
Spec	Input Signal	HDbaseT/HDMI
	Input Signal Level	Refer to standard
	Impedance	Differential 100ohm
	Input Bandwidth	300Mhz
	Input Channels	2
	Power Consumption	12W

- Support IP network coded signal
- Support up to 4K/1920x1200@60Hz
- Support EDID、OSD
- Support input cropping



IP Input Card

Spec sheet		
Port	10/100 / 1000M Ethernet X2	
Spec	Input Signal	10/100 / 1000M Ethernet
	Input Signal Level	IEEE standard
	Input Channels	1
	Power Consumption	18W

Input / Output Cards

I Output cards I

- Support digital signal conversion into DVI-I signal output
- Support up to 1920x1200@60Hz
Support VGA with DVI-VGA adapter
- Support multi-window roaming,
Seamlessly real-time switching etc.



4 Channels DVI-I Output Card

Spec sheet		
Port	DVI-I	
Spec	Input Signal	HDMI/DVI/VGA
	Input Signal Level	TMDS
	Impedance	Differential 100ohm
	Input Bandwidth	165Mhz
	Input Channels	4
	Power Consumption	20W



2 Channels HDMI 4K@60Hz Output Card

- Support digital signal conversion into HDMI 4K signal output
- Support up to 4K 3840x2160@30Hz,
3840x1080@120Hz
- Support multi-window roaming,
Seamlessly real-time switching etc.

Spec sheet		
Port	HDMI 2.0	
Spec	Input Signal	HDMI
	Input Signal Level	TMDS
	Impedance	Differential 100ohm
	Input Bandwidth	600Mhz
	Power Consumption	20W

Input / Output Cards

- Support digital signal conversion into HDBaseT signal output
- Support up to 1920x1200@60Hz
- Support multi-window roaming, Seamlessly real-time switching etc.



4 Channels HDBaseT Output Card

Spec sheet		
Port	HDBaseT	
Spec	Input Signal	HDBaseT
	Input Signal Level	refer to HDBaseT standard
	Impedance	Differential 100ohm
	Input Bandwidth	165Mhz
	Input Channels	4
	Power Consumption	48W



4 Channels DVI-D Output Card

- Support up to 1920x1200@60Hz
- Support non-standard resolution
- Support multi-window roaming, Seamlessly real-time switching etc.

Spec sheet		
Port	DVI-D	
Spec	Input Signal	HDMI/DVI
	Input Signal Level	TMDS
	Impedance	Differential 100ohm
	Input Bandwidth	165Mhz
	Input Channels	4
	Power Consumption	28W

Input / Output Cards

- Support 2 Channels HDMI
- Support up to 1920x1200@60Hz
- Support non-standard resolution
- Support multi-window roaming, Seamlessly real-time switching etc.



4 Channels HDMI Output Card

Spec sheet		
Port	HDMI 1.3b	
Spec	Input Signal	HDMI/DVI
	Input Signal Level	TMDS
	Impedance	Differential 100ohm
	Input Bandwidth	165Mhz
	Input Channels	4
	Power Consumption	20W



4 Channels SDI Output Card

- Support 4 channels SDI
- Support 3G/HD/SD SDI
- Support up to 1920x1080@60Hz
- Support lone driver

Spec sheet		
Port	SDI BNCX4	
Spec	Input Signal	3G/HD/SD SDI
	Input Signal Level	2.0V VPP
	Impedance	75ohm
	Input Bandwidth	2.97Gbps
	Input Channels	4
	Power Consumption	16W

Input / Output Cards

I Other cards I



System Control Card

- Support controlling system
- Support software connecting with upper computer
- Support standard RS232 input/output, RJ45 100M network port

Spec sheet		
Port	RS232 10/100M Ethernet	
Spec	Input Signal	RS232/RJ45
	Default network address	192.168.1.200
	RS232 Baud rate	9600
	RS232 Protocol	Without parity, 8-bit data and 1-bit stop
	RS232 loop out	For
	Power Consumption	20W

- Support connecting monitors to view real-time echo screens that are fully synchronized with the big screen



Real-time Preview Card

Spec sheet		
Port	DVI	
Spec	Output Signal	DVI
	Signal Standard	TMDS
	Max Num. Of Preview Signals	8



Preview Card

- Support IP network to send up to 64 signals on the processor after encoding. You can check the signal status and display the big screen status in real time through a computer or pad.

Spec sheet		
Port	10/100/1000M Ethernet x1, HDMI	
Spec	Output Signal	10/100/1000M Ethernet
	Signal Standard	IEEE 802.3
	Max Num. Of Preview Signals	64

Contact us

National Toll Free	40068-03568	
Telephone	021-65100018/66011776	
Fax	021-66011776-8004	
Website	http://www.mviewtech.com	
Address	6th Floor, Building 7, No. 10, Songliang Road, Baoshan District, Shanghai	
Mailbox	support@mviewtech.com (Technical Support)	support@mviewtech.com (Technical Support)